

Sliding contact switch with rubber fee



Typical Specifications

Items		Specifications
Rating (max.)/(min.) (capacitor load)		50mA 16V DC / 10μA 1V DC
Contact resistance (Initial/After operating life)		200mΩ max. / 400mΩ max.
Operating force		1.96N, 2.45N, 3N
Operating life	Without load	100,000 cycles
	With load	100,000 cycles (50mA 16V DC)

Product Line

Total travel (mm)	Operating force	Poles	Positions	Minimum order unit (pcs.)		Product No.
				Japan	Export	
1.6	1.96N	1	1	2,000	8,000	SPEH110101
	2.45N					SPEH120101
	3N					SPEH130103

Packing specifications

Taping

Number of packages (pcs.)			Tape width (mm)	Export package measurements (mm)
1 reel	1 case /Japan	1 case /export packing		
2,000	4,000	8,000	12	393×393×107

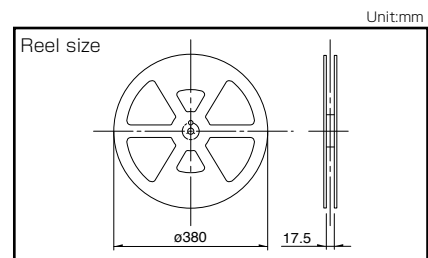

Dimensions

Style	Unit:mm
-------	---------

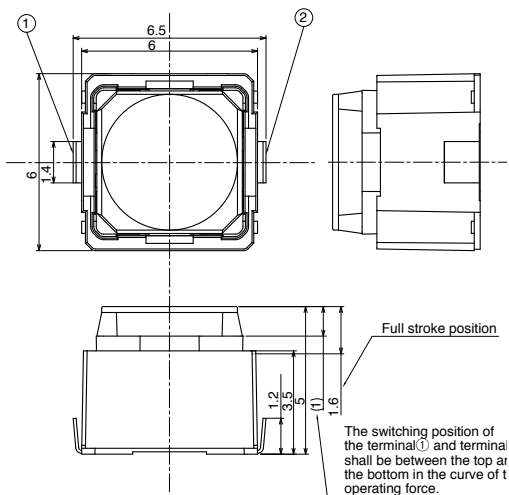



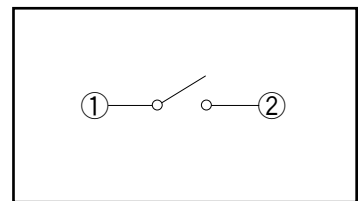



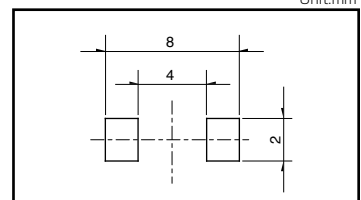

Circuit Diagram



Land Dimensions



Refer to P.130 for soldering conditions.

Series		Vertical				
		SPEH	SPEJ	SPPH4	SPPH1	
Photo						
Dimensions (mm)	W	6	7	6.5	10	
	D	6	7	8.5	10	
	H	5	5.95	8.5		
Travel (mm)		—	—	2.2	1.5	
Total travel (mm)		1.6	1.7	3	2.5	
Number of poles		1	2			
Operating temperature range		-40°C to +90°C	-40°C to +85°C	-10°C to +60°C		
Automotive use		●	●	—	●	
Life cycle						
Rating (max.) (Resistive load)		50mA 16V DC	0.2A 14V DC	0.1A 30V DC		
Rating (min.) (Resistive load)		10μA 1V DC	—	50μA 3V DC		
Durability	Operating life without load	100,000cycles 400mΩ max.	10,000cycles 150mΩ max.	10,000cycles 100mΩ max.	10,000cycles 40mΩ max.	
	Operating life with load (at max. rated load)	100,000cycles 400mΩ max.	10,000cycles 150mΩ max.	10,000cycles 100mΩ max.	10,000cycles 40mΩ max.	
Electrical performance	Initial contact resistance	200mΩ max.	150mΩ max.	100mΩ max.	20mΩ max.	
	Insulation resistance	100MΩ min. 100V DC	100MΩ min. 500V DC			
	Voltage proof	250V AC for 1minute	500V AC for 1minute			
Mechanical performance	Terminal strength	—	—	5N for 1minute		
	Actuator strength	Operating direction	50N	49N	30N	50N
		Pulling direction	—	—	10N	—
Environmental performance	Cold	-40°C 1000h	-40°C 500h	-20°C 96h		
	Dry heat	90°C 1000h	85°C 500h	85°C 96h		
	Damp heat	60°C, 90 to 95%RH 1000h	60°C, 90 to 95%RH 500h	40°C, 90 to 95%RH 96h		
Page		119	120	121	122	

Push Switches Soldering Conditions	130
Push Switches Cautions	131

Note

● Indicates applicability to all products in the series.

Example of Reflow Soldering Condition

1. Heating method: Double heating method with infrared heater.
2. Temperature measurement: Thermocouple ϕ 0.1 to 0.2 CA (K) or CC (T) at soldering portion (copper foil surface).
A heat resisting tape should be used for fixed measurement.
3. Temperature profile

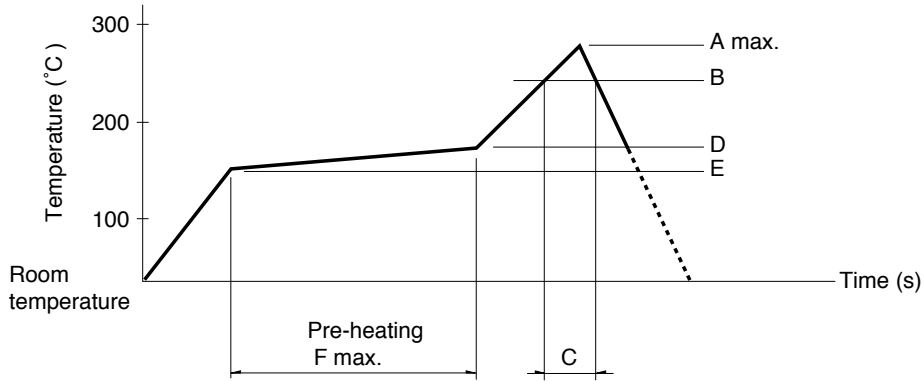

Series (Reflow type)	A (°C) 3s max.	B (°C)	C (s)	D (°C)	E (°C)	F (s)
SPEJ	260	230	40	180	150	120
SPEF						
SPEH						

Notes

1. The condition mentioned above is the temperature on the mounting surface of a PC board. There are cases where the PC board's temperature greatly differs from that of the switch, depending on the PC board's material, size, thickness, etc.
The above-stated conditions shall also apply to switch surface temperatures.
2. Soldering conditions differ depending on reflow soldering machines. Prior verification of soldering condition is highly recommended.

Reference for Hand Soldering

Series	Soldering temperature	Soldering time
SPPJ3, SPPJ2, SPUN, SPPH4, SPPH1	350±10°C	3+1/0s
SPED2, SPED4	350±10°C	3±0.5s
SPEJ	350±10°C	4s max.
SPEF	350±5°C	3s max.
SPEH	350°C max.	3s max.
SPUJ	300±10°C	3+1/0s

Reference for Dip Soldering

(For PC board terminal types)

Series	Items		Dip soldering	
	Preheating temperature	Preheating time	Soldering temperature	Duration of immersion
SPPJ3	100°C max.	60s max.	260±5°C	5±1s
SPUN	100°C max.	60s max.	260±5°C	10±1s
SPUJ, SPPH4	—		260±5°C	5±1s
SPPJ2, SPPH1, SPED2, SPED4, SPEF	—		260±5°C	10±1s