

RK163 16mm Size Metal Shaft Type

A wide range of versatile products applicable for various types of control

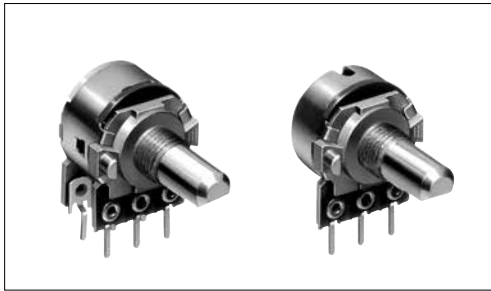

Typical Specifications

Items	Specifications
Total resistance tolerance	±20%
Maximum operating voltage	150V AC, 5V DC
Total rotational angle	300° ±3°
Rotational torque	3 to 25mN·m
Operating life	15,000 cycles
Operating temperature range	-10°C to +70°C

Product Line

Number of resistor elements	Mounting direction	Shaft type	Terminal style	Length of the shaft L ₁ (mm)	Center detent	Total resistance (kΩ)	Resistance taper	Minimum order unit (pcs.)		Products No.	Drawing No.	
								Japan	Expert			
Single-unit	Horizontal type	Flat	For PC board	15	Without	10	1B	600	1,200	RK1631110TBK	1	
				20						RK1631110TT3		
			Lead	RK1631110U1Q								
		Serrated	For PC board	15			20	600	1,200	RK1631110TNP	2	
				Lead			20	600	1,200	RK1631110TTU	3	
			Lead	15			200	400	RK1631110U0Q	4		
Dual-unit for tone	Horizontal type	Flat	For PC board	20	With	10	1B	600	1,200	RK1631210AWN	5	
				15	RK1631210A2							
				20	RK1631210AX9							
Serrated		For PC board	15	Without	50	15A				RK16312A0B85	5	
			20		3B	RK16312A0BKH						
			25		10	15A				RK16312A0BKR		
Dual-unit for vol.	Horizontal type	Flat	For PC board		15	Without	10	15A	600	1,200	RK16312A0B85	5
					20		3B				RK16312A0BKH	
					25		10				15A	
Serrated		For PC board	15	Without	10		15A				RK16312A0B85	5
			20		3B		RK16312A0BKH					
			25		10		15A				RK16312A0BKR	

Note

Other varieties are also available. Refer to "Other Specifications" (P.327).

Packing Specifications

Bulk







Terminal style	Number of packages (pcs.)		Export package measurements (mm)
	1 case /Japan	1 case /export packing	
For PC board	600	1,200	532×326×386
Lead	200	400	360×270×155

Refer to P.327 for other specifications.
 Refer to P.328 for attached parts.
 Refer to P.329 for ordering products not listed.
 Refer to P.343 for soldering conditions

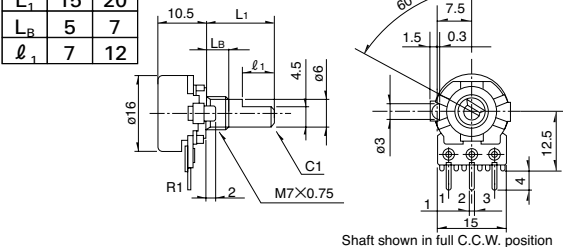
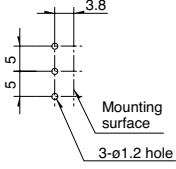
RK163 16mm Size Metal Shaft Type

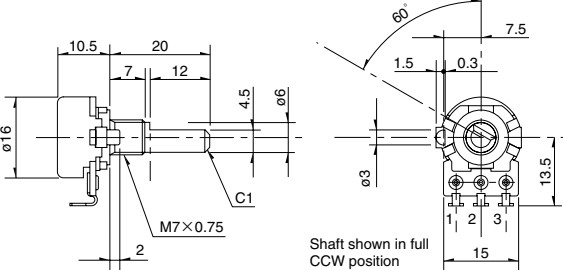
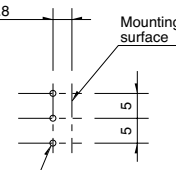
Dimensions

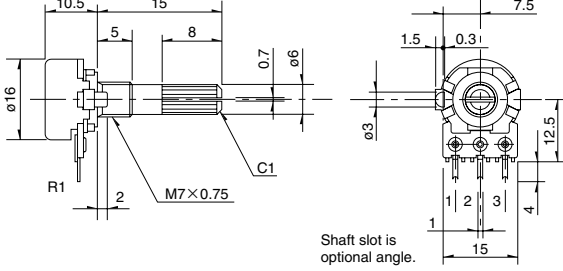
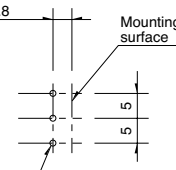
Unit:mm

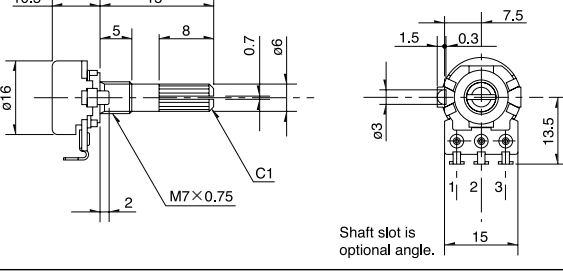
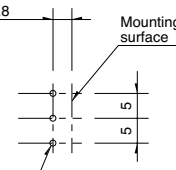
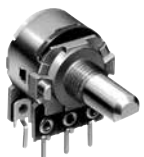
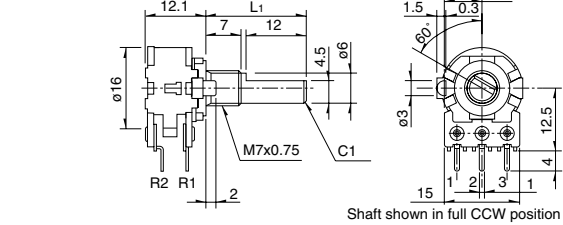
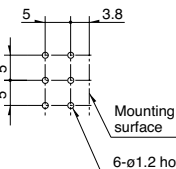
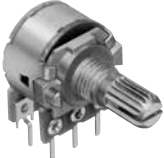
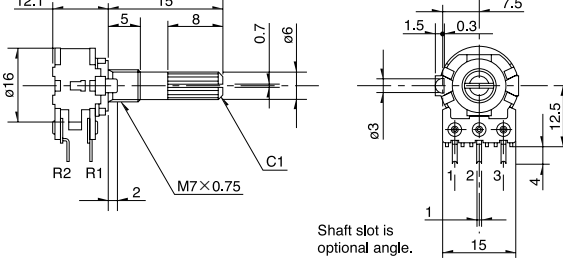
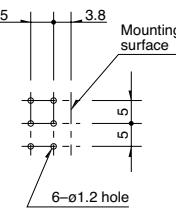
No.	Photo	Style	PC board mounting hole dimensions (Viewed from mounting side)									
1		<table border="1" data-bbox="592 353 726 443"> <tr> <td>L_1</td> <td>15</td> <td>20</td> </tr> <tr> <td>L_B</td> <td>5</td> <td>7</td> </tr> <tr> <td>l_1</td> <td>7</td> <td>12</td> </tr> </table> 	L_1	15	20	L_B	5	7	l_1	7	12	
L_1	15	20										
L_B	5	7										
l_1	7	12										
2												
3												
4												
5		<table border="1" data-bbox="592 1507 726 1541"> <tr> <td>L_1</td> <td>20</td> <td>25</td> </tr> </table> 	L_1	20	25							
L_1	20	25										
6												

16mm Size Metal Shaft Type / Other Specifications

In addition to the products listed, we can accommodate the follow specifications.

Product Specifications and Applications

Type	Model	Applications	Detent variety
Single-shaft, single-unit	RK16311	General	Center
Single-shaft, dual-unit	RK16312	General or Volume and tone control	

Total Resistance Variety

Total resistance (kΩ)	5	10	20	50	100	200

Resistance Taper

Resistance taper	15A	1B	3B	15C

Dimensions of Shaft

1) 18 teeth serrated type

Unit:mm

L ₁	L _B	l ₁
15	5	8
20	5	12
25	7	12
30	7	12

● The serration angle shall be as shown.

2) Flat type

Unit:mm

L ₁	L _B	l ₁
15	5	7
20	7	12
25	7	12
30	7	12

Shaft shown in full CCW position

3) Slotted type

Unit:mm

L ₁	L _B
15	7
20	7
25	7
30	7

Shaft shown in full CCW position

Note

Marked are specifications recommended by Alps Alpine.
Die-cast shaft is standard.

16mm Size Metal Shaft Type / Attached Parts

The following parts are included with the product.

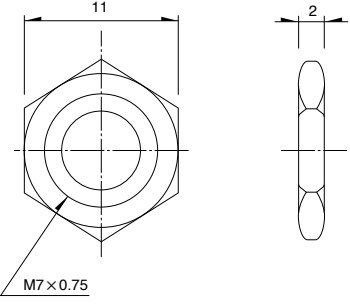
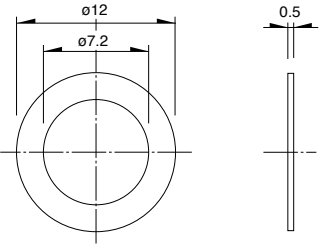
		Unit:mm	
Nut		Washer	
			

Rotary
Potentialmeters
Slide
Potentialmeters

Metal
Shaft

Insulated
Shaft

Knob
Operating

Through
Shaft Type

Ring
Type

16mm Size Metal Shaft Type / Ordering Products Not Listed

When ordering product varieties that are not listed, specify referring to the examples below.

Sample Part Number

R K 1 6 3 1 1 1 0 - F 2 0 - C 0 - B 1 0 3 - P

Model type

Code	Model type
111	Single-unit
121	Dual-unit for tone
12A	Dual-unit for vol.

Shaft type

Code	Shaft type
F	Flat
S	Slotted
K	Serrated

Length of the shaft L₁ (mm)

Code	Length of the shaft	Code	Length of the shaft
15	15	25	25
20	20	30	30

Detent

Code	Detent
C0	Without
C1	Center

Resistance taper

Code	Resistance taper	Code	Resistance taper
A	15A	V	3B
B	1B	C	15C

B: For tone & general
(model type : 111, 121)

V: For vol. (model type : 111, 12A)

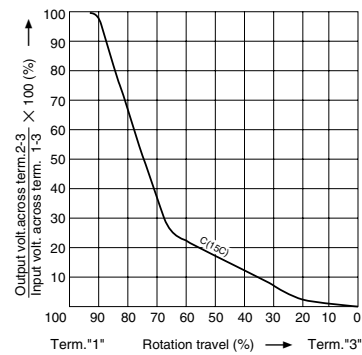
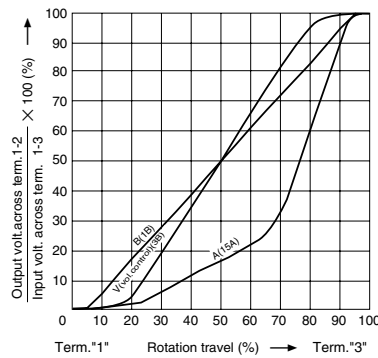

Total resistance











Code	Total resistance (k Ω)	Code	Total resistance (k Ω)
502	5	503	50
103	10	104	100
203	20	204	200

Terminal Style

Code	Terminal style
P	For PC board
L	Lead terminal

Note

Marked are specifications recommended by Alps Alpine.

Type	16mm size	20mm size	27mm size	50mm size	Rotary motor-driven	
Series	RK163	RK203	RK271	RK501	RK168	
	Single-shaft					
Number of resistor elements	Single/dual	Single	Single/dual/quad	Dual/quad	Dual/quad/5-ganged/6-ganged	
Photo						
Terminal mounting	Horizontal	Vertical	Horizontal			
Fixing method of bushing	Bushing screw clamp					
Operating temperature range	-10°C to +70°C	-40°C to +85°C	-10°C to +70°C			
Operating life	15,000 cycles	30,000 cycles	15,000 cycles			
Available for automotive use	—	○	—	—	—	
Life cycle (availability)						
Electrical performance	Total resistance (k Ω)	5, 10, 20, 50, 100, 200	10	5, 10, 20, 50, 100, 250	10, 20, 50, 100	
	Resistance taper	15A, 1B, 3B, 15C	B	15A, 3B		
	Rated Power	0.1W 0.05W (15A)	0.05W		0.1W	0.05W
	Residual resistance	R ≤ 10kΩ 20Ω max. 10kΩ < R ≤ 50kΩ 30Ω max. 50kΩ < R < 3MΩ Nominal total resistance of 0.1% or less%	—	R ≤ 10kΩ 20Ω max. 10kΩ < R < 50kΩ 30Ω max. 50kΩ ≤ R Nominal total resistance of 0.1% or less%	—	—
	Maximum attenuation (Volume control)	5kΩ ≤ R < 10kΩ 70dB min. 10kΩ ≤ R < 50kΩ 80dB min. 50kΩ ≤ R < 100kΩ 90dB min. 100kΩ ≤ R 100dB min.	—	5kΩ ≤ R < 10kΩ 70dB min. 10kΩ ≤ R < 50kΩ 80dB min. 50kΩ ≤ R < 100kΩ 90dB min. 100kΩ ≤ R 100dB min.	120dB min.	5kΩ ≤ R < 10kΩ 70dB min. 10kΩ ≤ R < 50kΩ 80dB min. 50kΩ ≤ R < 100kΩ 90dB min. 100kΩ ≤ R 100dB min.
	Gang error applicable to Dual-unit parts for audio volume control purposes	-40dB to 0dB 3dB max.	—	-70dB to -60dB 3dB max. -60dB to 0dB 2dB max.	-100dB to 0dB 2dB max.	-60dB to -40dB 5dB max. -40dB to 0dB 3dB max.
	Insulation resistance	100MΩ min. 500V DC	10MΩ min. 250V DC	100MΩ min. 500V DC		100MΩ min. 250V DC
	Voltage proof	500V AC for 1minute	300V AC for 1minute	500V AC for 1minute		300V AC for 1minute
	Center-taps	Without				
Mechanical performance	Detent	Without, Cente	17	Without, Center, 21, 31, 41	Without	
	Stopper strength	0.9 N·m	0.5 N·m	0.9 N·m	1.5 N·m	0.9 N·m
	Push-pull strength	100N max.		150N max.	100N max.	
	Vibration	10 to 55 to 10Hz/min., the amplitude is 1.5mm for all the frequencies, in the 3 direction of X, Y and Z for 2 hours respectively				
Shaft style	Serrated type, Flat type, Slotted type	Flat type	Slotted type, Flat type	Slotted type	Flat type	
Terminal style	Insertion, Lead	Insertion				
Attached switch	—	—	—	—	—	
Page	325	330	333	337	339	

Metal Shaft Potentiometers Soldering Conditions	343
Potentiometers Cautions	418
Potentiometers Measurement and Test Methods	420
Potentiometers Resistance Taper	422

Note

○ Indicates applicability to some products in the series.

Reference for Manual Soldering

Series	Tip temperature	Soldering time	No. of solders
RK09L, RK097	350°C max.	3s max.	1 time
RK203	300°C max.	3s max.	1 time
RK119	350±10°C	3 ⁺¹ ₀ s	1 time
RK271	350°C max.	5s max.	1 time
RK501	350±10°C	5 ⁺¹ ₀ s	1 time
RK163	350°C max.	5s max.	1 time
RK168	Potentiometer terminal	300°C max.	3s max.
	Motor terminal	350°C max.	2s max.

Reference for Dip Soldering

Series	Preheating		Dip soldering		No. of solders
	Soldering surface temperature	Heating time	Soldering temperature	Soldering time	
RK09L, RK097, RK203	100°C max.	2 min. max.	260±5°C	5±1s	2 time max.
RK501	120±10°C	2 min. max.	260±5°C	5±1s	2 time

Example of Reflow Soldering Condition

Temperature profile

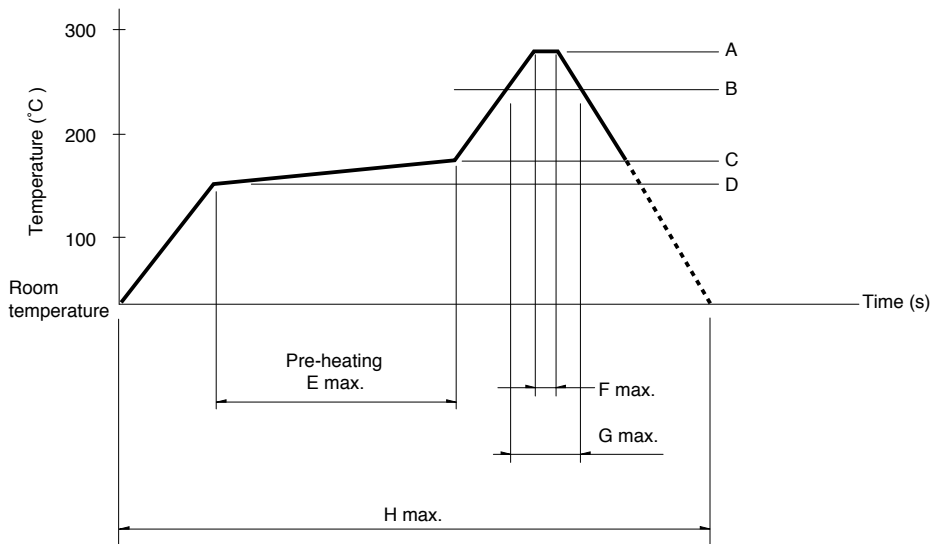

Series	A	B	C	D	E	F	G	H	No. of reflows
RK119	260°C	230°C	180°C	150°C	2 min.	3s	40s	4 min.	2 time max.

Notes

1. When using an infrared reflow oven, solder may sometimes not be applied. Be sure to use a hot air reflow oven or at type that uses infrared rays in combination with hot air.
2. The temperatures given above are the maximum temperatures at the terminals of the potentiometer when employing a hot air reflow method. The temperature of the PC board and the surface temperature of the potentiometer may vary greatly depending on the PC board material, its size and thickness. Ensure that the surface temperature of the potentiometer does not rise to 250°C or greater.
3. Conditions vary to some extent depending on the type of reflow bath used. Be sure to give due consideration to this prior to use.