

**Pressure Sensor
HSPPAD143A
Application Note**

-CONTENTS-

1	BASIC INFORMATION.....	3
1.1	What is atmospheric pressure?.....	3
1.2	What is water pressure?.....	3
2	Pressure sensor HSPPAD143A.....	5
2.1	Overview	5
2.2	Structure.....	5
2.3	Block Diagram.....	5
3	Design Guide	6
3.1	Mounting position (heat source).....	6
3.2	Mounting Board	7
3.3	Ultrasonic Cleaning.....	8
3.4	Terminal Short.....	8
4	Legal Disclaimer.....	8

1 BASIC INFORMATION

1.1 What is atmospheric pressure?

It is the strength of atmospheric pressure. Equal to the weight of all air in the air column extending vertically up to the space where the atmosphere disappears on the unit area (1 m²) of a certain point. This mass (weight) corresponds to the force of pushing up the height of the mercury column up to 0.760 m under the temperature of 0 °C. This is defined as one atmospheric pressure (symbol atm) which is a standard atmosphere. Relationship with various units is 1 atm = 760 mm Hg = 101,325 Pa = 1013.25 hPa. That is, the mass of air per 1 m² at sea level altitude 0 m is about 10,000 kg weight (10 t). 10 t are converted to units of force, it is 100,000 N (Newton), when expressed in terms of pressure, it is about 100,000 Pa (Pascal). Since 100 Pa is 1 hPa (hectopascal), it is approximately the same as 1013.25 hPa at 100,000 Pa = 1000 hPa.

The atmospheric pressure also varies with altitude and latitude. The standard atmospheric pressure (1 atm) is set to 1013.25 hPa on the sea surface, but since the atmospheric pressure is the pressure indicating the weight of the upper air, it decreases to the higher place.

Barometric pressure and elevation can be calculated by the formula provided by the "International Civil Aviation Organization" (ICAO) below.

$$H (m) = 44330.77 \times \{1 - (P / 101325)^{0.190263}\}$$
$$P (Pa) = 101325 \times \{(288.15 - 0.0065 \times H) / 288.15\}^{5.25588}$$

Table 1 shows the relationship between atmospheric pressure and altitude.

1.2 What is water pressure?

Water pressure is the pressure that water exerts on objects and water itself. In water with open water surface it is proportional to the depth from the water surface. Water pressure increases by 1 kg/cm² every 10 m of water. (Increase by about 1 atm)

Pressure and water depth can be calculated by the following formula.

$$D (m) = (101325 - P) / 9800$$
$$P (Pa) = (101325 + 9800) \times D$$

Table 2 shows the relationship between pressure and water depth.

Table.1 Correlation of altitude and the atmospheric pressure

High degree(m)	Pressure(kPa)
0	101.325
1000	89.875
2000	79.495
2500	74.683
3000	70.109
3500	65.764
4000	61.640
4500	57.728
5000	54.020
5500	50.507
6000	47.181
6500	44.035
7000	41.061
7500	38.251
8000	35.600
8500	33.099
9000	30.742
9500	28.524
10000	26.436

Table.2 Water depth and pressure

Water depth(m)	Pressure(kPa)
1	111.125
10	199.325
20	297.325
30	395.325
40	493.325
50	591.325
60	689.325
70	787.325
80	885.325
90	983.325
100	1081.325
110	1179.325
120	1277.325
130	1375.325
140	1473.325
150	1571.325

2 Pressure sensor HSPPAD143A

2.1 Overview

Pressure sensor HSPPAD143A is a digital interface pressure sensor.

The pressure is detected by the MEMS sensor element using a piezo-resistive bridge circuit formed on the silicon diaphragm. The sensor element is connected to the ASIC for signal conditioning.

HSPPAD143A pressure sensor is products for atmospheric pressure detection and water pressure detection.

2.2 Structure

The HSPPAD series pressure sensor adopts the MEMS structure to convert the change of the atmospheric pressure into the resistance change of the piezo resistance.

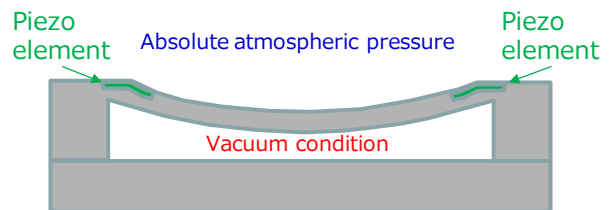
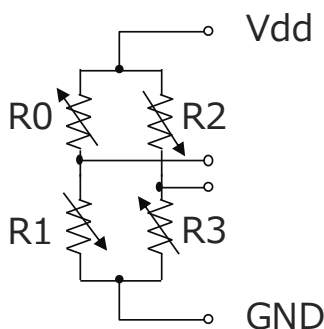

Cross section of pressure sensor

2.3 Block Diagram

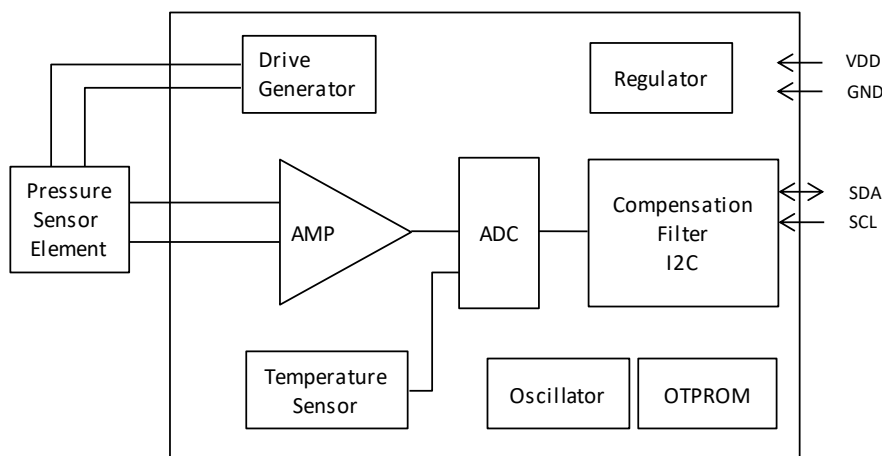

The ASIC has 17 bit ADC and temperature compensation function. The output of the ASIC corrects the pressure value. There are products that correspond to I2C.

3 Design Guide

3.1 Mounting position (heat source)

If a sudden temperature change occurs, there is a possibility that the accuracy of the sensor may be affected.

As far as possible, install in a place away from the heat source.

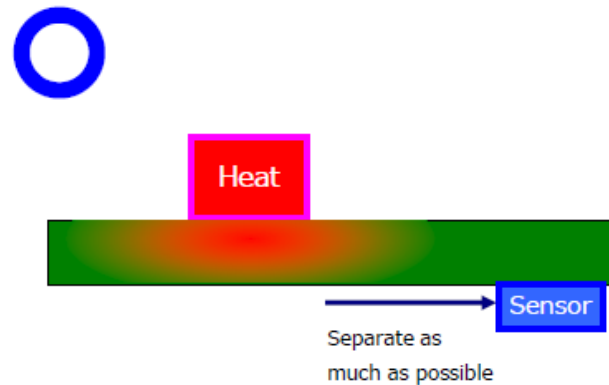
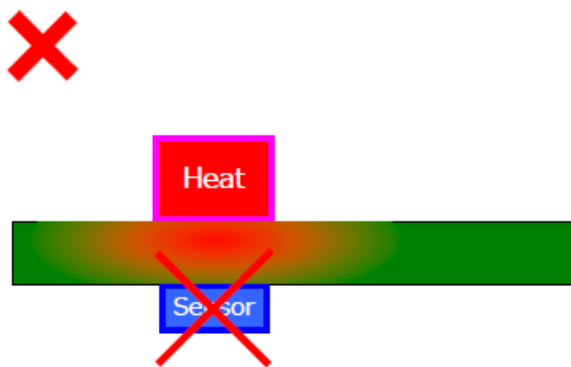
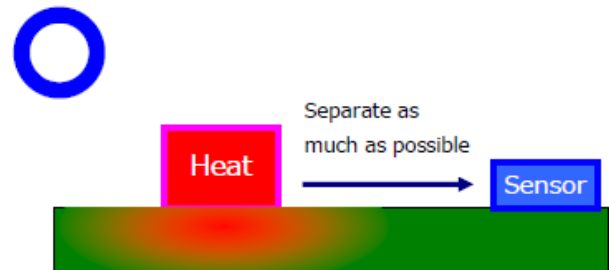
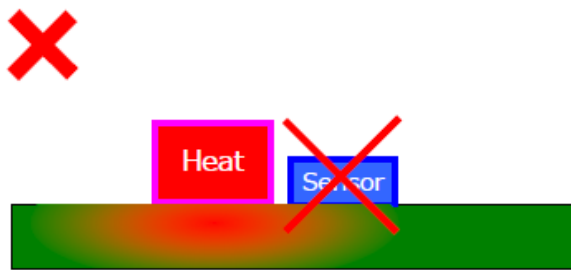

3.2 Mounting Board

It is important to use a substrate having a small coefficient of thermal expansion. The sensor element deforms due to thermal expansion and affects the reading accuracy of pressure.

In addition, when the board is deformed due to parts mounted around the sensor, the sensor element may be deformed in the same way and influence the accuracy of reading the pressure in some cases. If the surrounding area is covered with resin to protect the sensor, carefully check the variation of sensor characteristics after resin application before use. If the applied resin exerts an unexpected residual stress on the sensor, the sensor output value may fluctuate.

Do not apply a load force to the sensor cylindrical part after mounting on the board.

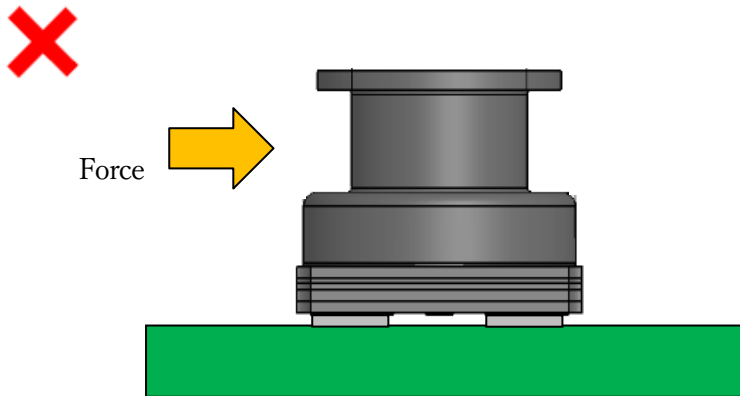

3.3 Ultrasonic Cleaning

When ultrasonic waves are applied, the diaphragm of the sensor may be damaged (the sensor may not be damaged or function).

3.4 Terminal Short

If any of the terminals of the sensor package is shorted by mounting board, other circuits on the same wiring may be affected.

4 Legal Disclaimer

The information provided herein is only meant as a guide. AlpsAlpine provides no warranty or guarantee with respect to the information or use thereof, express or implied, by law or otherwise. AlpsAlpine specifically disclaims any and all implied warranties of merchantability, noninfringement, and fitness for a particular purpose.

AlpsAlpine does not represent or guarantee that the use of this information will not cause disruptions, that errors will be eliminated, or that this information will meet your requirements. Use of the information provided herein is made entirely at your own risk.

AlpsAlpine shall not be liable for any damages arising out of the use of the information provided herein, whether special, indirect, intentional, punitive, incidental, derivative, inevitable damage, loss of business interest or loss to business of a third party, whether based in contract or tort, even if informed of the possibility of such damage, and regardless of legal theory.